



# EBDSPIR-DM

## Ceiling PIR presence detector – D-Mate

### Overview



The EBDSPIR-DM is a combined passive infrared (PIR) motion sensor and photocell designed to be part of a D-Mate system.

Functioning as a presence detector, the unit can turn lights on when a room is occupied and off when the room is empty. Optional settings allow lights to be turned off in response to ambient daylight, or to implement a maintained illuminance (daylight harvesting) system.

All functionality is fully programmable using an IR handset.

### Features

#### Front features

Mounting Bezel

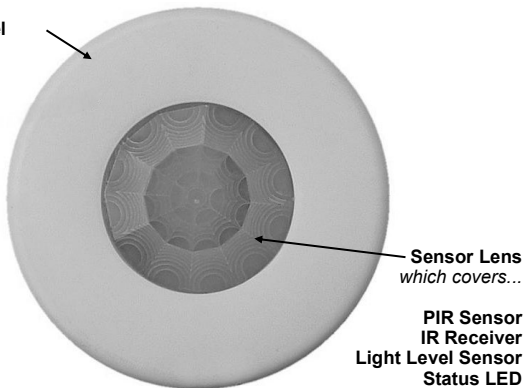

Sensor Lens  
which covers...  
PIR Sensor  
IR Receiver  
Light Level Sensor  
Status LED

#### PIR Sensor

Detects movement within the unit's detection range, allowing load control in response to changes in occupancy.

#### IR Receiver

Receives control and programming commands from an IR (infrared) handset.

#### Light Level Sensor

Measures the overall light level in the detection area

#### Status LEDs

The LED flashes **Red** or **Green** to indicate the following:

<b>Walk Test LED active</b>	when movement is detected
<b>Valid setting received</b>	
<b>Factory reset</b>	

#### Back features

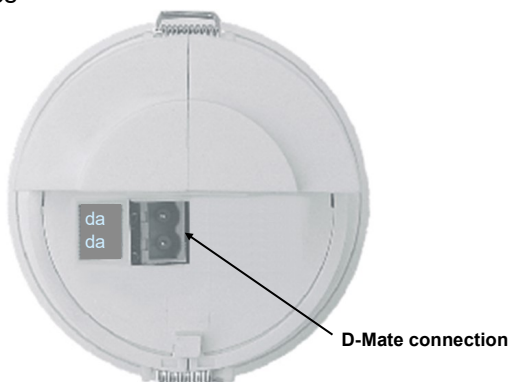

D-Mate connection

#### D-Mate connection

Connection to the D-Mate bus. The D-Mate bus is polarity insensitive.

# D-Mate

D-Mate is a Lighting Control System suitable for small to medium scale applications offering the following key benefits:

- 4 independently dimmable lighting circuits. *An additional 4 circuits can be programmed via the UNLCDHS.*
- Scene setting - 4 user programmable scenes (plus an 'off' scene) per Scene plate.
- Scene recall via push-button Scene Plates, Input Units or IR handsets
- Presence and absence operation using detectors
- Lux switching and lux dimming (maintained illuminance) operation

## Introduction

Devices within the D-Mate system communicate via a simple two wire data bus. The bus is powered via the D-Mate PSU and data is passed between devices using a format based around the DALI standard. The bus operates at a nominal voltage of 16 Volts DC which serves to provide operating power to each device connected to the bus. A maximum current of 200mA is available from the PSU. Therefore, in any D-Mate system, the maximum number of devices will be dependant on the total current consumption of all devices, including ballasts.

*Note: The use of additional D-Mate PSUs or third party PSUs with a higher current rating is not permitted.*

The output from the DM-SL-PSU is fully isolated from the mains input and may be regarded as an SELV device. However, as DALI ballasts only offer basic insulation, all devices on the D-Mate bus must be wired as if carrying mains potential.

## Physical requirements

Data bus connections between devices must be made using suitable mains-rated two-core cable, such as two-core flex or bell wire. The minimum recommended core size is 0.75mm<sup>2</sup> for most applications. The data bus may be wired using any convenient network topology (e.g. line, star or tree). However, whichever topology is used, the total length of all cable (including spurs) within a system should not exceed 200m. There is no requirement to use screened cable. However, the routing of cables through electrically 'noisy' environments should be avoided to prevent possible interference on the bus.

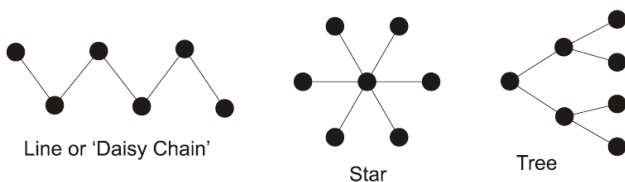

The data bus/power connections to all D-Mate devices are designed to operate correctly with reversed polarity. However, it is good practice to ensure all devices are wired with correct polarity. DALI and DSI ballasts are tolerant to reversed polarity, however, 1-10V ballasts are not.

## Multiple Device Control (Master and Slaves)

It is possible to use multiple D-Mate control devices, such as detectors and plates in a system. For example there may be a need to have two plates in a room where the master plate controls all the circuits in the room but the slave plate is used to control a subset of circuits. An application of this would be where there are two detectors in a large room, where one would be the master and the other the slave.

Where multiple control devices are used on the same circuit, one device must be designated the 'master'. This is the device that is responsible for sending control messages to the Addressers. The master device also stores the levels for each Scene for the circuit(s) it controls. The other control devices on that circuit must be designated as 'slaves'. These do not control the Addressers directly, but send messages to the master device which then sends messages to the Addressers. Where a detector exists on a circuit it must always be the master device, with any additional detectors or scene plates configured as slaves. Where a single detector is used with one more scene plates, it will automatically set the plates to slaves for the corresponding circuits. To set the detector as a slave use either the UHS5 or UNLCDHS to set via IR.

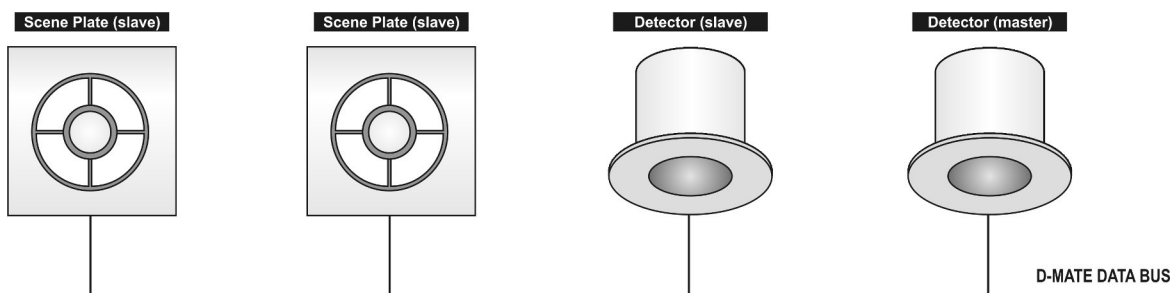

## Detection Mode

The Detection Mode can be set to behave in Presence or Absence mode:

- **Presence** When movement is detected the load will automatically turn on. When the area is no longer occupied the load will automatically switch off after an adjustable time period.
- **Absence** The load is manually switched on via the D-Mate scene plate or input unit. When the area is no longer occupied the load will automatically switch off after the adjustable time period has elapsed.

In either case, sensitivity to movement of the PIR sensor can be adjusted using the Sensitivity parameter.

*HINT: To assist in setting the Sensitivity, turn on the Walk Test LED which will flash red when movement is detected.*

## Switch Level On/Off

Occupancy detection can be made dependant on the ambient light level using the Lux On Level and Lux Off Level parameters.

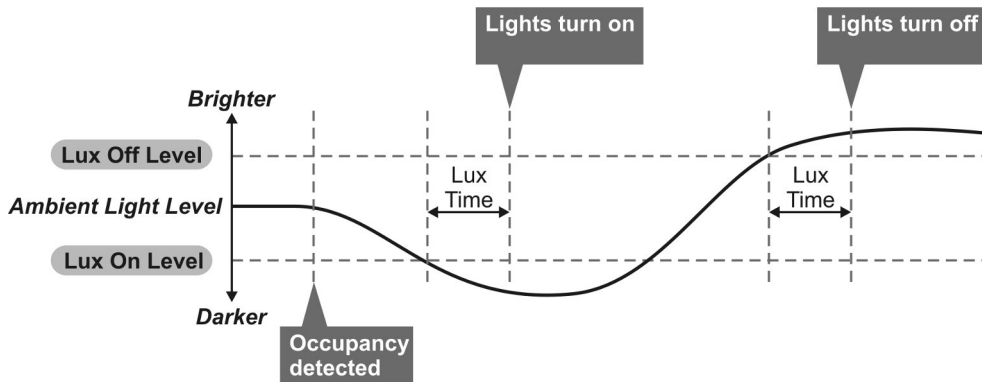

## Maintained Illuminance (daylight harvesting)

The detector measures the overall light level in the detection area and calculates the correct output for the luminaires, to achieve a preset lux level (maintained illuminance or daylight harvesting). Only the master detector in a system can provide maintained illuminance information.

# Burn-in

## Overview

It is a requirement of many fluorescent lamp manufacturers to have the lamps on at maximum output for a period of time to guarantee lamp life (refer to the manufacturer's datasheet for details) As this D-Mate system is able to dim the lamps, the product provides a facility to disable this for a given period of time.

## Operation

By setting the "Burn in" parameter, you can select a time during which the lamps are not allowed to deviate from maximum output. The unit counts the time, and even remembers how long has elapsed in the event of a power failure. To cancel the burn in function, simply select a time of 0. Note that when the lamps are changed, the burn in time should be set again.

# Readback function (UNLCDHS handset only)

The UNLCDHS has the ability to read back the settings stored in a device.

## To read back individual parameters

- Navigate to the parameter and press the 'R' (Read) button whilst pointing at the device. The handset will click when the parameter has been read back, the device will flash its LED, and the value will be shown against the parameter in the menu.

## To read back all of the parameters in a menu

- Press and hold the 'R' (Read) button for more than 1 second.
- The handset will click every time a parameter is received
- The device will show multiple flashes of its LED
- All of the values will be shown against the parameters in the menu.
- The individual parameters may be edited and then saved as a 'Macro'.

## Notes

- If a parameter(s) has been missed because of a communication error, the missing value(s) is replaced by dashes.

# Installation

## Choosing a Suitable Location

The EBDSPiR-DM is designed to be ceiling mounted and must satisfy the following criteria:

- Avoid positioning the unit where direct sunlight may enter the sensor element.
- Do not site the sensor within 1m of any lighting, forced air heating or ventilation.
- Do not fix the sensor to an unstable or vibrating surface.
- Do not exceed maximum length of cable (200m) on data bus.
- Do not exceed maximum bus loading (200mA).

## Wiring diagram

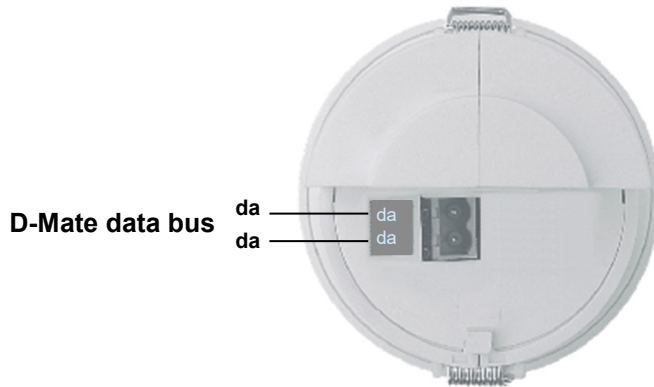

## System wiring example

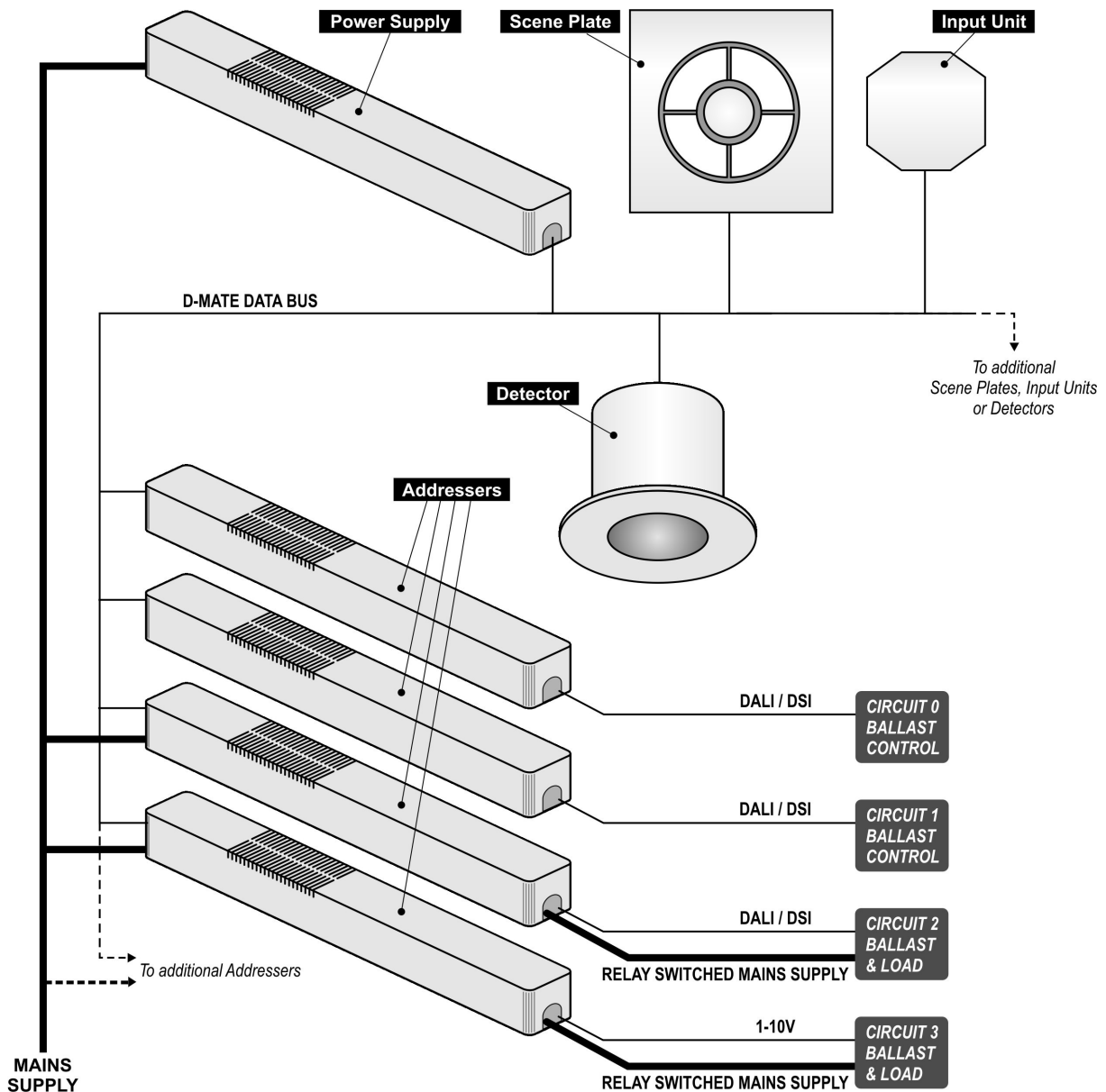

The EBDSPiR-DM is designed to be mounted using either:

- Flush fixing, or
- Surface fixing, using the optional Surface Mounting Box (part no. DBB).

Both methods are illustrated below.

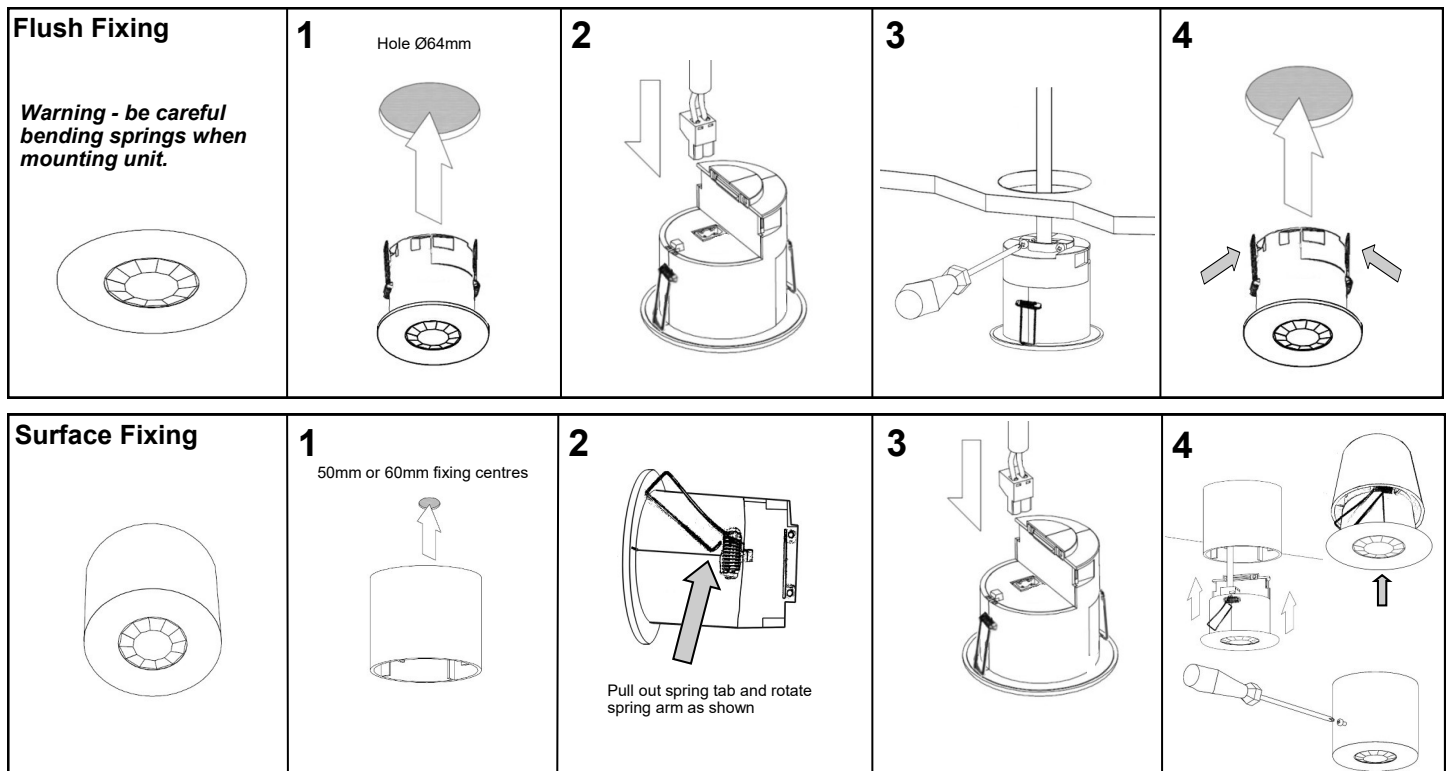

## Wire stripping details

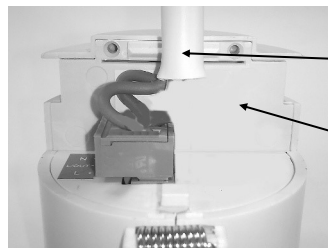
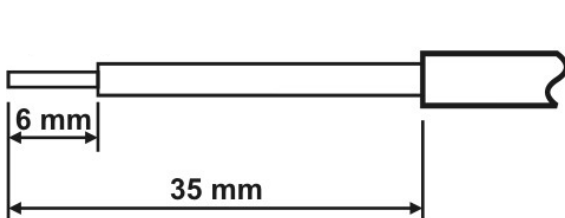

### Important

Ensure that the cables are formed as shown before affixing the cable clamp. The clamp **MUST** clamp the outer sheath(s) only.

Bend cores as shown.

## Power-up test procedure

When power is applied to the unit, the load will turn on immediately.

Set the timeout to 10 seconds, vacate the room or remain very still and wait for the load to switch off .

Check that the load switches on when movement is detected.

The unit is now ready for programming.

## Fault finding

### What if the load does not turn ON?

- Check that the live supply to the circuit is good.
- Check that the D-Mate bus is wired correctly.
- Check the Master and Slave settings.
- If the detection range is smaller than expected, check the diagram on page 2. Rotating the sensor slightly may improve the detection range.

HINT: The Walk Test LED function can be used to check that the unit is detecting movement in the required area.

### What if the load does not turn OFF?

- Ensure that the area is left unoccupied for longer than the Time Out Period.
- Ensure that the sensor is not adjacent to circulating air, heaters or lamps.

# Basic programming

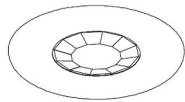

The functionality of the EBDSPIR-DM is controlled by a number of parameters which can be changed or programmed by any of the following devices:

- **UHS5** Infrared Handset. See below for programmable functions.
- **UNLCDHS** Infrared Handset (with LCD). See user guide for full programming details.

For most basic programming operations the UHS5 handset can be used and the following procedures are based on using this device.

Point the handset at the Sensor and send the required programming commands to the unit as shown below.

Valid commands will be indicated by a green LED flash. See page 1 for details of other LED responses.

*Note: other functions on the UHS5 which are not shown below are not applicable to this product.*

Parameter Name	Default Value	Number of Shift key presses				UHS5 Handset Graphics	Description
		0 SHIFT 1 SHIFT 2	1 SHIFT 1 SHIFT 2	2 SHIFT 1 SHIFT 2	3 SHIFT 1 SHIFT 2		
<b>Button Activation</b>							
On / Raise		On	Raise				Turn lights on or to raise lights.
Off / Lower		Off	Lower				Turn lights off or to lower lights.
Walk test	Off	On	Off				When set to On this causes a red LED to flash on the sensor when it detects movement. Use this feature to check for adequate sensitivity levels.
Time Out (Time adjustment)	20 mins	1, 10 & 20 minutes	5, 15 & 30 minutes	10 seconds			Once the detector is turned on, this value sets how long the lights will stay on once movement has ceased.
Lux on level (Switch level on)	9	2, 5 & 7	4, 6 & 9				Lux level setting to prevent the luminaires being switched on if the ambient light level is sufficient (adjustable between 1 and 9). The luminaires will always be switched on at level 9.
Light Level	6 (600)			2 (200) 5 (500) 6 (600) 7 (700)	4 (400) 6 (600) 9 (999)		Sets a target light level to be maintained by the lighting system. 9 (999) = disabled.
Lux off level (Switch level off)	9	2, 5 & 7	4, 6 & 9				Lux level setting to switch the luminaires off during occupancy if the ambient light level goes above the setting (adjustable between 1 and 9). Level 9 will always keep the lights on. This setting can be used for "window row switching". <i>Note: the Lux Off Level value must always be greater than the Lux On Level value.</i>
Sensitivity	9	1, 5 & 9	3, 6 & 8				Sensitivity level for detecting movement. 1 = low sensitivity 9 = high sensitivity
Defaults				D			Returns the unit to the default settings.
Presence / Absence	Presence	Presence	Absence				Presence mode allows the output to turn on when movement is detected and off when movement ceases. Absence mode allows the output to turn off when movement ceases, but must be manually turned on first.
Burn-in	0	0	50	100			Determines how long the output will be at 100% so that lamps 'burn-in'. The 'burn-in' time is not affected by power supply interruptions.
Preset ABS	Master	A	B	Capped mode R/L (default, see p7)			2 presets for Master / Slave configuration: • A: Master • B: Clear Master
Preset PRS		A	B	Broomstick mode R/L (see p7)			2 presets for Master / Slave configuration: • A: Slave • B: Clear Slave
Shift							Use this button to select the settings in red and blue signified by the 'Shift 1' and 'Shift 2' LEDs

# Advanced programming

Parameter Name	Default Value	Range / Options	Description	UHS5	UNLCDHS
Detection Mode	Presence	Presence or Absence	Presence mode allows the output to turn on when movement is detected and off when movement ceases. Absence mode allows the output to turn off when movement ceases, but must be manually turned on first.	✓	✓
Walk Test LED	Off	On or Off	When set to On this causes a red LED to flash on the sensor when it detects movement. Use this feature to check for adequate sensitivity levels.	✓	✓
Time Out (Time adjustment)	20 minutes	0-99 minutes	Once the detector is turned on, this value sets how long the lights will stay on once movement has ceased. Select 0 for 10 second delay – use for commissioning only.	✓	✓
Absence Time Out	30 seconds	0-999 seconds	Set the Absence Mode On Button Timeout (timeout period before the outputs go back off if no detector was triggered after the on button was pressed).	✗	✓
Lux on level (Switch level on)	9	1 to 9 For a higher resolution a scale of 101-199 is available	Sets a minimum light level below which the PIR sensor is enabled, allowing lights to be turned on by movement. <i>Note: the Lux Level Off value must always be greater than the Lux Level On value.</i>	✓	✓
Lux off level (Switch level off)	9	1 to 9 For a higher resolution a scale of 101-199 is available	Sets a maximum light level above which the PIR sensor is disabled, preventing lights from being turned on by movement.	✓	✓
Lux On Time	0	0-999 mins	Sets number of minutes below on level before output allowed to come back on.	✗	✓
Lux Off Time	0	0-999 mins	Sets number of minutes above off level before output goes off.	✗	✓
Light Level (maintained illuminance)	600	1 to 998 (999 disabled)	Sets a target light level to be maintained by the lighting system.	✓	✓
MI Max	99	0-99	Maximum dimming level used when daylight linking.	✗	✓
MI Min	0	0-99	Minimum dimming level used when daylight linking.	✗	✓
Sensitivity On	9	1 (min) to 9 (max)	Sensitivity level for detecting movement when the detector is already on. <b>*UHS5 sets Sensitivity On and Off to the same value.</b>	✓*	✓
Sensitivity Off	9	1 (min) to 9 (max)	Sensitivity level for detecting movement when the detector is off. <b>*UHS5 sets Sensitivity On and Off to the same value.</b>	✓*	✓
Disable Detector	N	Y or N	Disables detection. This mode is used when the unit is for maintained illuminance only.	✗	✓
IR Enabled	N	Y or N	Enable or disable device control or programming by IR handset.	✗	✓
Burn-in	0	0 (disabled) or 1 to 999 hours	Determines how long the output will be at 100% so that lamps 'burn-in'. The 'burn-in' time is not affected by power supply interruptions.	✓	✓
Fade Time	2 (1 second)	1 (0.7s) 2 (1.0s) 3 (1.4s) 4 (2.0s) 5 (2.8s) 6 (4.0s) 7 (5.7s) 8 (8.0s)	Sets the default fade rate for circuits using DALI ballasts. Value is sent to all Addressers on Detector/Plate power up and when changed, and must be set to the same value for all devices.	✗	✓
Max Value	99	0-99%	Sets the maximum light level for all circuits.	✗	✓
Min Value	1	0-99%	Sets the minimum light level for all circuits.	✗	✓
Master Circuit Ch1	0	0-14	First circuit number that device is a master of.	✗	✓
Master Circuit Ch2	1	0-14	Second circuit number that device is a master of.	✗	✓
Master Circuit Ch3	2	0-14	Third circuit number that device is a master of.	✗	✓
Master Circuit Ch4	3	0-14	Fourth circuit number that device is a master of.	✗	✓
Slave Circuit Ch1	0	0-14	First circuit number that device is a slave of.	✗	✓
Slave Circuit Ch2	1	0-14	Second circuit number that device is a slave of.	✗	✓
Slave Circuit Ch3	2	0-14	Third circuit number that device is a slave of.	✗	✓
Slave Circuit Ch4	3	0-14	Fourth circuit number that device is a slave of.	✗	✓
Scene 0 Levels Ch1-4	0	0-100%	Levels applied to each of the four channels (circuits) when Scene 0 (off scene) is selected.	✗	✗
Scene 1 Levels Ch1-4	100	0-100%	Levels applied to each of the four channels (circuits) when Scene 1 is selected.	✗	✓
Scene 2 Levels Ch1-4	75	0-100%	Levels applied to each of the four channels (circuits) when Scene 2 is selected.	✗	✓
Scene 3 Levels Ch1-4	50	0-100%	Levels applied to each of the four channels (circuits) when Scene 3 is selected.	✗	✓
Scene 4 Levels Ch1-4	25	0-100%	Levels applied to each of the four channels (circuits) when Scene 4 is selected.	✗	✓
Scene 5-9 Levels Ch1-4	100	0-100%	Levels applied to each of the four channels (circuits) when Scene 5, 6, 7, 8 or 9 are selected.	✗	✓

# Advanced programming

<b>User Modes</b>					
<b>Parameter Name</b>	<b>Default Value</b>	<b>Range / Options</b>	<b>Description</b>	<b>UHS5</b>	<b>UNLCDHS</b>
On			Selects last Scene.	✓	✓
Off			Turns lights off.	✓	✓
Raise	-	-	Increase light level. Reverts when occupancy cycle complete.	✓	✓
Lower	-	-	Decrease light level. Reverts when occupancy cycle complete.	✓	✓
Scene up	-	-	Steps up between 9 pre-defined scenes.	✗	✓
Scene down	-	-	Steps down between 9 pre-defined scenes.	✗	✓
Select Scene	-	0-9	Select the individual scene.	✗	✓
Circuit Number	1	1-4	Select the circuit to adjust level of.	✗	✓
Circuit Level	99	0-99%	Set the circuit level for the circuit above. <i>Note; only operates if the Scene Plate is the Master.</i>	✗	✓
Save Scene	-	-	Saves the set levels in the selected scene. <i>Note; only operates if the Scene Plate is the Master.</i>	✗	✓
Raise from off	Y	Y/N	When scene raising, parameter allows outputs which are off to switch on, as opposed to staying off. Useful for switched loads.	✗	✓
Lower to off	Y	Y/N	When scene lowering, parameter allows outputs to go completely off as opposed to staying at minimum.	✗	✓
Broomstick R/L	N (Capped)	Y/N	Broomstick mode keeps the difference in a scene's channel levels during scene raising lowering and maintained illuminance. <i>Note; that when the lead channel reaches either 100% or 0% the differentials will reduce till the last channel reaches 100% or 0% .</i>	✓	✓



This page intentionally left blank

## Technical data

Dimensions See diagrams opposite  
 Weight 0.07kg  
 Supply Voltage 9.5VDC—22.5VDC via DALI  
 Supply Current 8mA

D-Mate bus Cannot be considered as SELV since DALI, DSI and 1-10V ballasts only offer basic insulation, therefore all devices on the D-Mate bus must be wired as if carrying mains potential.

Terminal Capacity 2.5mm<sup>2</sup>  
 Temperature -10°C to 35°C  
 Humidity 5 to 95% non-condensing  
 Material (casing) Flame retardant ABS and PC/ABS  
 Type Class 2  
 IP rating IP40

Compliance EMC-2014/30/EU  
 LVD-2014/35/EU

For further compliance information visit [www.cpelectronics.co.uk/compliance](http://www.cpelectronics.co.uk/compliance)



### EBDSPIR-DM

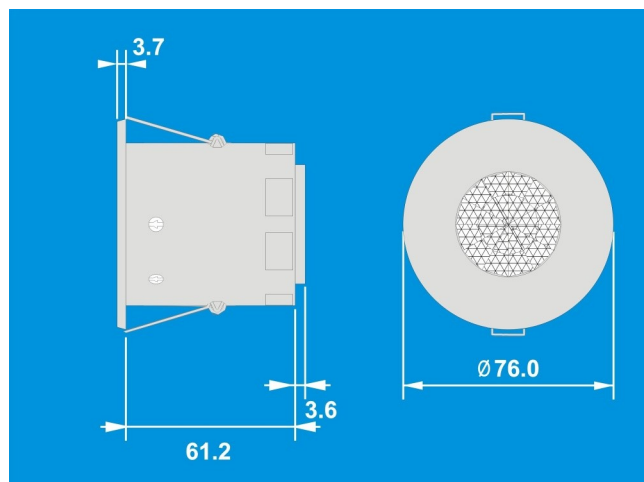

### DBB

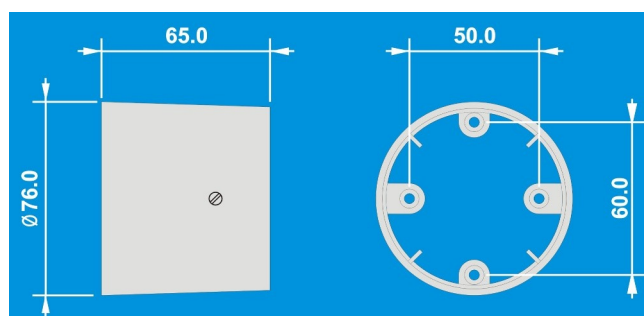

## Detection diagram

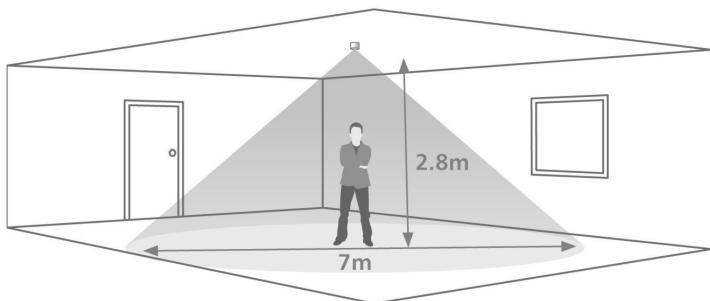

Area of high sensitivity Area of lower sensitivity

## Part numbers

	Part number	Description
<b>Detector</b>	EBDSPIR-DM	D-Mate ceiling PIR presence detector
<b>Accessories</b>	DBB	Surface mounting box
	UHS5	Programming IR handset
	UNLCDHS	Universal LCD IR handset

**UK Patent no. GB2467196**  
 International patents pending

### IMPORTANT NOTICE!

This device should be installed by a qualified electrician in accordance with the latest edition of the IEE Wiring Regulations and any applicable Building Regulations.

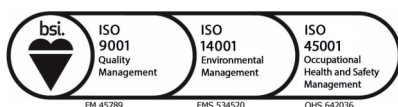

**C.P. Electronics Ltd**  
 Brent Crescent  
 London  
 NW10 7XR  
 United Kingdom  
 Tel: +44 (0) 333 900 0671  
 Fax: +44 (0) 333 900 0674  
[www.cpelectronics.co.uk](http://www.cpelectronics.co.uk)  
[enquiry@cpelectronics.co.uk](mailto:enquiry@cpelectronics.co.uk)